

DISASTER RECOVERY SOLUTION USING VIRTUALIZATION TECHNOLOGY

THE DISASTER RECOVERY PROJECT II
AT SAP CO-INNOVATION LAB TOKYO



CONTENTS

4 Disaster Recovery Solution for SAP® ERP, and at a Lower Cost	13 Establishing the Network Environment
4 Importance of DR (Disaster Recovery) measures to ensure business continuity	13 Cost reduction by FCoE protocol
4 DR solution for backbone systems using virtualization technology	13 Connections to the server and storage
4 Joint demonstration tests by six companies at SAP Co-Innovation Lab Tokyo	14 WAAS, the WAN acceleration solution
5 Key elements of the test environment	14 Using WAAS to achieve effective use of bandwidth
6 Verification scenario	15 Key points for establishing a network environment
7 Establishing the Server Environment	16 Disaster Recovery in a Virtual Environment
7 Server + VM (Virtual Machine) environment	16 Failover in a virtual environment
8 Intel® Xeon® 5500 series processor	16 Mock disaster response, to test recovery plans as often as desired
9 Dramatic evolution improves virtual environment performance	17 Major functions of the Site Recovery Manager
10 Establishing the Storage Environment	18 Disaster Recovery Potential Using Virtualization Technology
10 Replication using NetApp SnapManager for Microsoft SQL Server	18 DR measures using virtualization technology that benefits from an advanced technological environment
11 Setting the transfer interval, taking verification into consideration	18 Effective use of the DR site: Improving the value of IT assets
11 Controlling the storage environment from the server side	
11 Performance in an FCoE environment verified	
12 Advanced architecture of NetApp	

DISASTER RECOVERY SOLUTION FOR SAP® ERP, AND AT A LOWER COST

SIX COMPANIES PERFORM JOINT DEMONSTRATION TESTS AT SAP CO-INNOVATION LAB TOKYO

Importance of DR (Disaster Recovery) measures to ensure business continuity

Today, IT systems play a critical role in almost all companies. System malfunctions caused by natural disasters such as earthquakes and typhoons, or human-caused disasters such as terrorism and hacking, may lead to immeasurable damage to business operations. Japan is an earthquake-prone country, so maintaining the integrity of IT systems is vital in ensuring the success of any BCP (Business Continuity Plan). Effective DR (Disaster Recovery) capacity is increasingly a compliance issue as well.

Normally, DR solutions involve installing the same hardware environment at a remote DR site as that used by the system at the operation site, synchronizing data by replication. This kind of solution is typically expensive. On the other hand, inexpensive solutions still have a disadvantage: they require complicated operations and difficult changeover procedures after a disaster.

The operation of a backbone system, which should be one of a company's most important IT assets, may seriously impact on the entire business processes of the company. As a result, many companies hesitate to adopt a DR solution.

DR solution for backbone systems using virtualization technology

DR solutions using virtualization technology are now attracting attention as an option to solve these issues. Virtualization technology can reduce the number of physical servers, and is also effective for DR solutions required for a backbone system. The technology lets users obtain virtual images at the operation site regularly, and replicate those images at the DR site, reproducing the operation site environment. Virtualization technology releases users from the need to maintain hardware with the same physical environments at both the operation site and the DR sites. In other words, users are able to create a flexible system environment at a lower cost.

Joint demonstration tests by six companies at SAP Co-Innovation Lab Tokyo

In July 2008, SAP Japan established SAP Co-Innovation Lab Tokyo in collaboration with its partners and customers, to carry out collaborative research and develop various solutions for the Japanese market. In September of the same year, SAP Japan, VMware Inc, NetApp K.K. and Intel Corporation successfully carried out Phase I of demonstration tests of the DR Solution, using virtualization technology.

During the subsequent Phase II of the Disaster Recovery Project, demonstration tests using up-to-date technology were carried out jointly by six companies, with Cisco Systems (a network

Key points of the Disaster Recovery Phase II Project of SAP Co-Innovation Lab Tokyo

1. Minimizing investment costs by integrating disaster recovery platforms through virtualization.
2. Establishing a disaster recovery platform using VMware's DR solution and NetApp's storage technology. Achieving seamless changeover in case of a disaster, including reliable data protection and tests/rehearsals.
3. Improving the performance of virtual environments using servers with Intel® Xeon® 5500 series processors
4. Allowing the seamless transitions across different IA platforms by Intel Virtualization Technology.
5. Establishing a network platform with the latest communication protocol, FCoE (Fibre Channel over Ethernet), to ensure a simple system environment with integrated I/O.
6. Speeding up replication for the DR site, using Cisco's WAN optimization solution.
7. Examining a scenario under which the disaster recovery platform is effectively used during normal operations, without lowering operation site performance through application of disaster recovery measures.

vendor) and Zacatii Consulting (a company with broad experience in DR solutions) as new participants. Phase II of the project builds on the success of Phase I, by separating the operation and DR sites. During Phase I the DR solutions for SAP ERP were located hypothetically in the same laboratory, using VMware's virtualization technology,

NetApp's storage technology and Intel's server platform.

Key elements of the test environment

Continuing from Phase I, which verified that transactions at the operation site were correctly reflected in the DR site

in a hypothetical environment, the following test environment was designed for Phase II (See Figure 1), based on Zacatii Consulting's experience and taking actual business purposes into consideration;

- At the operation site, two IA (Intel Architecture based) servers running

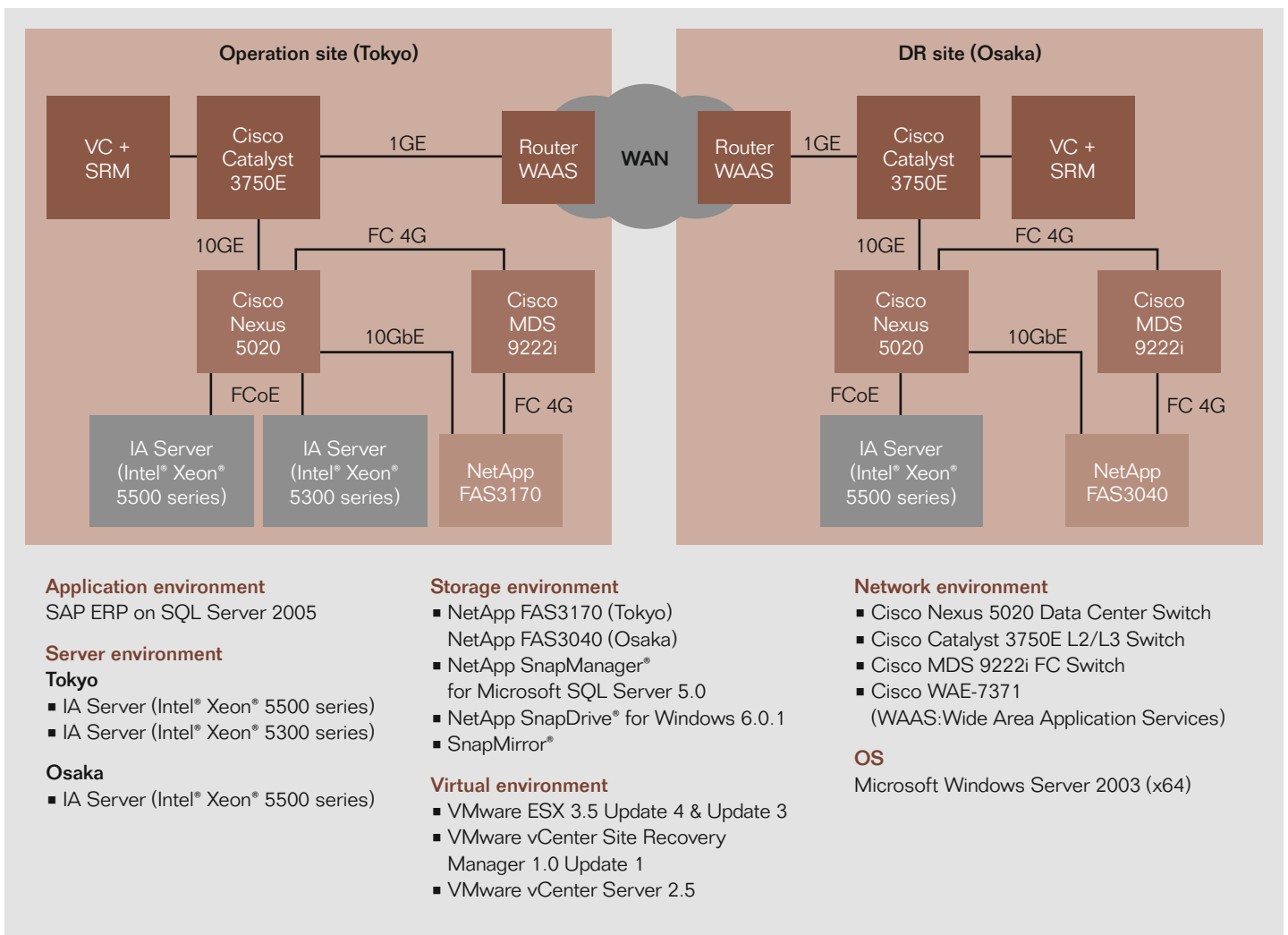

Figure 1: Configuration of verification environment

VMware ESX are installed, to comply with the assumption that more than one system is running. At the DR site, virtual machines are integrated into one IA server to minimize cost and achieve an environment assuming a 'many-to-one' server configuration.

- At the operation site, an Intel® Xeon® 5500 series processor-based server, designed for improved virtualization performance, and a server based on older generation Intel® Xeon® 5300 series processors, were used. At the DR site, an Intel® Xeon® 5500 series processor-based server was installed to verify that the data could be synchronized and that business could be continued in the environment with different mixed platforms.
- Synchronization was carried out simultaneously at the operation and DR sites, using NetApp's storage technology. It was confirmed that the aligned data was transferred without interrupting the system.
- A simple network environment was established by integrating FC (Fibre Channel) and Ethernet networks between the server and the storage system using the latest "FCoE (Fibre Channel over Ethernet)" network protocol.

- Packets were compressed using the WAN acceleration solution WAAS (Wide Area Application Services), by Cisco Systems' WAE-7371, to improve data transfer performance.
- The operation site was located in Tokyo and the DR site in Osaka, 500km away. The sites were connected by a VPN, which provides cost benefits.

Verification scenario

During Phase II of the project, verification of the technologies supplied by each partner and confirmation of the results of the entire project were conducted based on the design and verification scenario of Zacatii Consulting.

RPO¹ and RTO²

RPO (Recovery Point Objective) was verified for 2 to 3 hours, and RTO (Recovery Time Objective) was verified for 2 to 4 hours. RPO and RTO are both important indicators of the degree of business continuity. Targeted companies are middle-sized or larger companies, including retail businesses and EC businesses of small-sized companies that require a shorter RPO and RTO.

Replication

Data was replicated using NetApp's storage management software "NetApp SnapManager® for Microsoft® SQL Server™" and data replication software "SnapMirror®" every 60 minutes, to synchronize with the DR site while processing 5,000 to 10,000 transactions/hour with two virtual machines for ERP (host servers using Intel® Xeon® 5500 series processors and Intel® Xeon® 5300 series processors) at the operation site.

Business restart after a disaster (Failover)

VMware's VMware vCenter Site Recovery Manager (SRM), which manages and automates DR, is activated if the system at the operation site is stopped during the transaction. The tests confirmed normal operations of SAP ERP on the virtual machine at the DR site, and the correct reflection of transaction data of SAP ERP until the end of the synchronization.

1. RPO: An indicator that represents the timing or frequency of capturing backup data. Used in backing up and restoring operation verifications during the disaster recovery process.

2. RTO: An indicator that represents the time required for recovery of an information system, from the moment a disruption is caused by a system failure or disaster, until restoration to an agreed-upon service level. Used in BCP or DR operation verification.

ESTABLISHING THE SERVER ENVIRONMENT

LATEST SERVER PLATFORM SUPPORTS A STRONG VIRTUAL ENVIRONMENT

Server + VM (Virtual Machine) environment

The server configurations at the operation site (in Tokyo) and the DR site (in Osaka) are as described below (See Figure 2). It was assumed that the two physical servers at the operation site and one physical server at the DR site were all running before the new environment was established. The scenario called for the addition of a server with Intel's latest processor platform at both the operation site and DR site, thereby establishing a new DR site using the virtualization technology. It was verified that a flexible DR site could be established with different server environments.

Operation site

Three physical servers were installed at the operation site. Two of them have VMware ESX installed, and the other has VMware vCenter Server (vCenter Server) and VMware vCenter Site Recovery Manager (SRM) installed to manage the virtual environment in an integrated manner.

The virtual machines for ERP (ERP#1) and for the other applications (AD#1) were installed on a high-spec server with the latest Intel® Xeon® 5500 series processor.

The other server has an older generation Intel® Xeon® 5300 series processor to permit continuous use from the existing environment. On that server, the virtual machine for ERP (ERP#2) was installed.

DR site

Two physical servers were installed at the DR site. One of them is for the VC + SRM server, the other is a high-spec server with an Intel® Xeon® 5500 series processor and VMware ESX. The servers integrate the three virtual machines (ERP#1, ERP#2 and AD#1) managed by VMware ESX at the operation site into one host machine at the DR site.

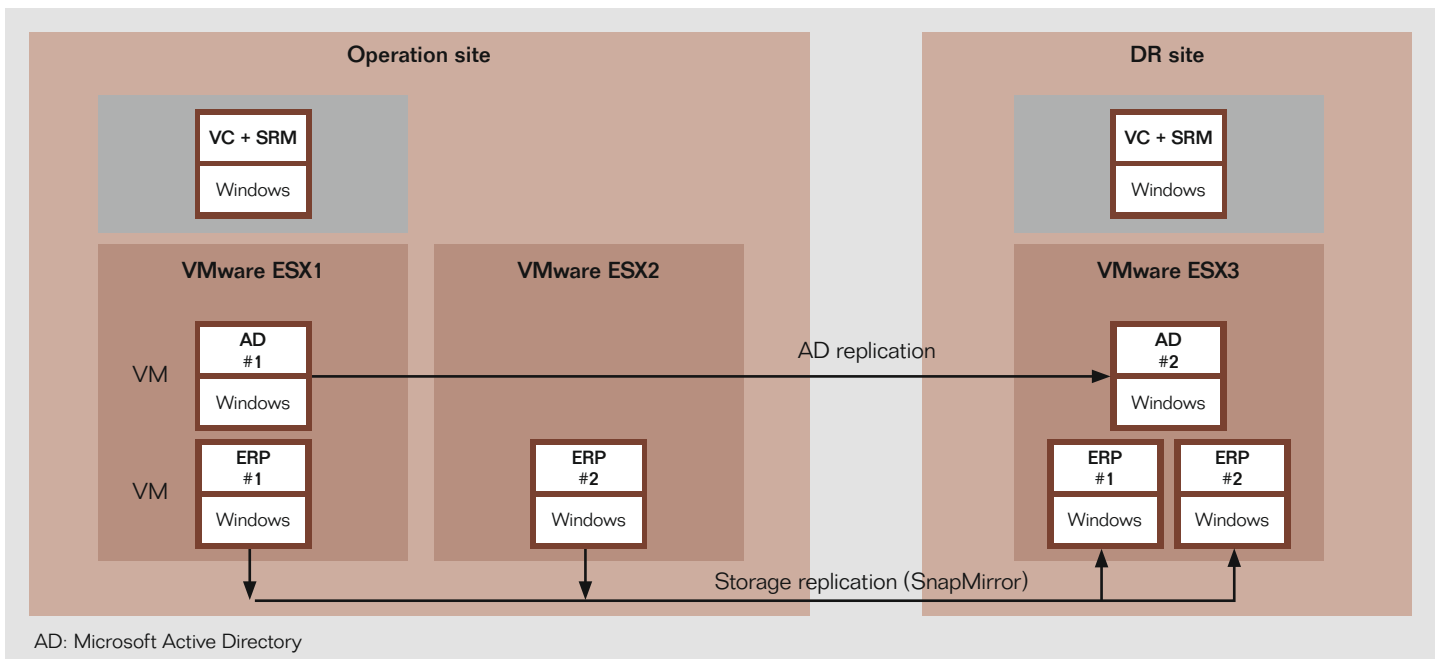

Figure 2: Server + VM environment

Synchronization method

AD#1 in a virtual machine automatically transfers the changes to others by Active Directory Replication Technologies. The virtual machines for ERP (ERP#1 and ERP#2) synchronize data using NetApp's storage function (SnapMirror and SnapManager for Microsoft SQL Server).

Intel® Xeon® 5500 series processor

The processor for the server released by Intel in March 2009, the Intel® Xeon® 5500 series processor, was used at the operation and DR sites for the demonstration tests. It was verified that they achieved more effective disaster recovery in the VMware virtual environment.

The Intel® Xeon® 5500 series processor is a completely revamped microarchitectural version developed from the former Intel® Core™ Micro Architecture. The new version represents the core

design technology of the processor, and features next-generation micro-architecture code-named "Nehalem." The Intel® Xeon™ 5500 series processor has four cores and supports the dual socket platform. The former FSB (front-side bus) was replaced with the faster QPI (QuickPath Interconnect) to connect the processor with the chipsets. It accesses memory directly and more quickly by using the memory controller embedded in the processor.

In addition, the processor has Intel® Intelligent Power Technology to reduce the power consumption of the core

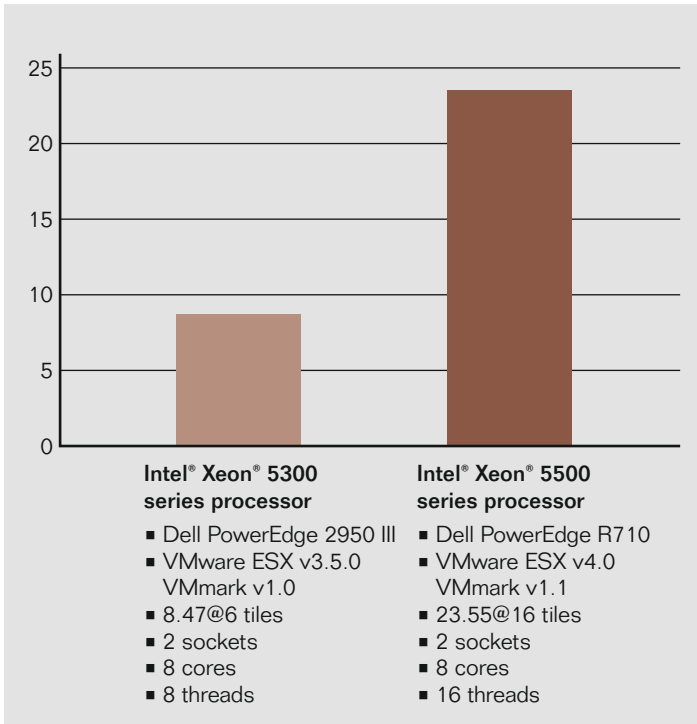

Figure 3: Results of VMmark benchmark
For details on the test environment, please visit www.vmware.com/products/vmmark/results.html.

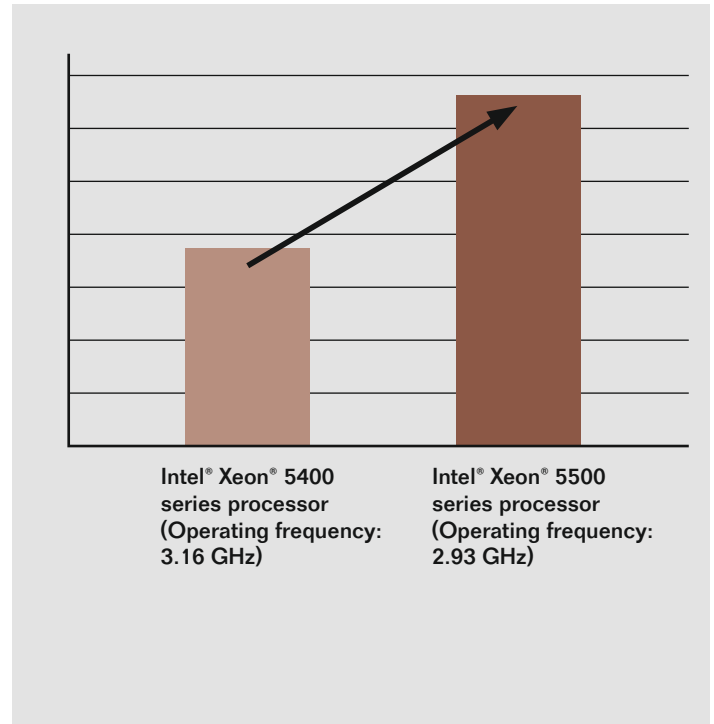

Figure 4: Virtualization performance test for SAP ERP
For details, please visit http://download.intel.com/business/software/testimonials/downloads/xeon5500/sap_virtualization.pdf

when idling to almost zero, using automatic controls and Intel® Turbo Boost Technology to raise operating frequency over the rated power for a heavier workload. This ensures further energy savings and improved performance. The various improvements of virtualization technology have brought to Intel® Xeon® Processor 5500 series.

Dramatic evolution improves virtual environment performance

The Intel® Xeon® 5500 series processor is evolving dramatically in virtualization. Intel® Virtualization Technology supports virtualization not only for the processor but also for the entire platform including chipsets and network interfaces, EPT (Extended Page Table). Intel® Virtualization Technology improves the entire performance and I/O and network performance as well.

The Dell PowerEdge R710 platform with Intel® Xeon® 5500 series processor scored 23.55 (16 tiles) for the VMmark benchmark, which evaluates application performance in a virtual environment (See Figure 3). It has achieved a performance about 2.8 times higher than the DellPowerEdge 2950 III platform, which used the former generation Intel® Xeon® 5300 series processor, and which scored just 8.47 (6 tiles).

The Sun Fire X4270 server (2 processors/8 cores/16 threads), with the Intel® Xeon® 5500 series processor, scores 3700 for SD benchmark by SAP ERP 6.0, as of March 30, 2009. For more information on the SAP SD benchmark, please visit www.sap.com/solutions/benchmark/index.epx.

In virtual performance tests for SAP ERP conducted by Intel, it was verified that the Intel® Xeon® 5400 series processor (3.16 GHz) and Intel® Xeon® 5500 series processor (2.93 GHz) achieved a performance 1.7 times higher (See Figure 4). Given these facts, SAP ERP has also been proved to achieve full performance in a virtual environment .

ESTABLISHING THE STORAGE ENVIRONMENT

TRANSFERRING THE VIRTUAL ERP MACHINE DATA TO THE DR SITE EVERY 60 MINUTES

Replication using NetApp SnapManager for Microsoft SQL Server

The LUN (Logical Unit Number) in the storage has the structure described below. When NetApp's storage management software (NetApp Snap Manager for Microsoft SQL Server) is implemented, the local backup function of the storage, Snapshot™, creates a backup image of the virtual machine data using very little data, and the replication tool SnapMirror transfers the

data to the DR site. At the DR site, the differential backup system of the storage saves the backup data for the previous seven sessions. The method and scheduling for synchronizing with the DR site depends on the feature of the LUN as described below (See Figure 5).

OS area and system area

The data in the OS area and system area are not changed except when the system is updated or a security patch is applied. Therefore, SAP ERP and

SQL servers are stopped to replicate data for the DR site only when any changes are made to the system.

UserData area

The logs and databases in the UserData area are replicated to the DR site online using SnapManager for Microsoft SQL Server. A command is performed every 60 minutes to transfer the backup data to the DR site.

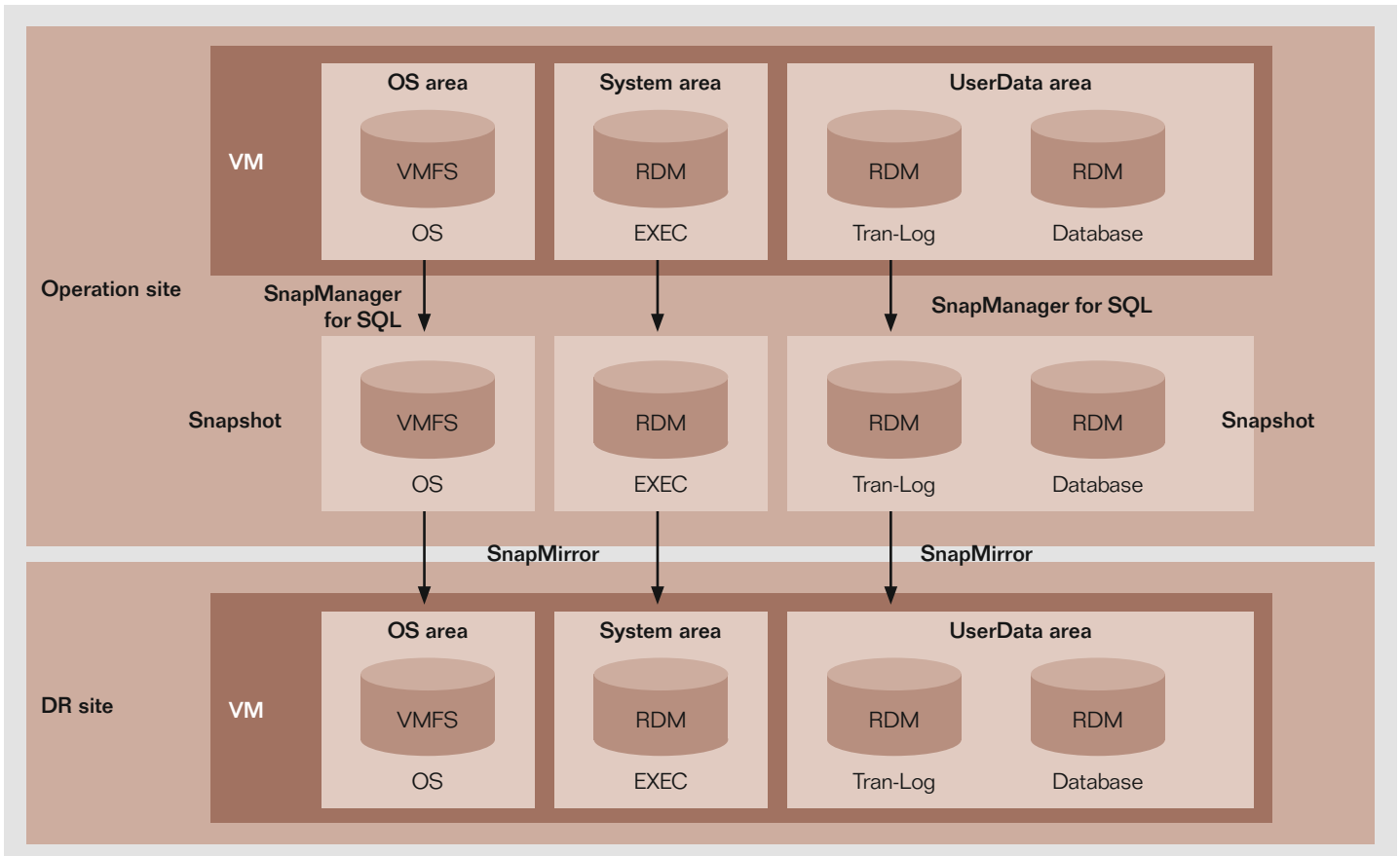

Figure 5: Storage configuration and synchronization method

Setting the transfer interval, taking verification into consideration

After transferring data to the DR site by SnapMirror, it is required to verify whether the data saved on the disc has no errors and conforms to the appropriate standards. In the demonstration tests, the interval between backup data transfers was set at a relatively short period of 60 minutes, and verification procedures were omitted. In the actual operation environment, the interval between transfers should be determined taking a possible longer verification time into consideration, due to the storage configuration and data features.

Controlling the storage environment from the server side

SnapManger for Microsoft SQL Server is used together with SnapDrive for Windows, a tool for automating storage management. Snap-Manager for Microsoft SQL Server is a data management tool specializing in backup and recovery together with SQL Server, and a kind of command center of SnapDrive for Windows. It acquires snapshots, creates clones, and restores backup data using SnapDrive for Windows functions.

The special function of SnapManager for Microsoft SQL Server is to control the storage environment from the server side. Virtualization of the server renders the storage/server boundary unclear. SnapManager for Microsoft SQL server enables users to carry out backup on the server side – something

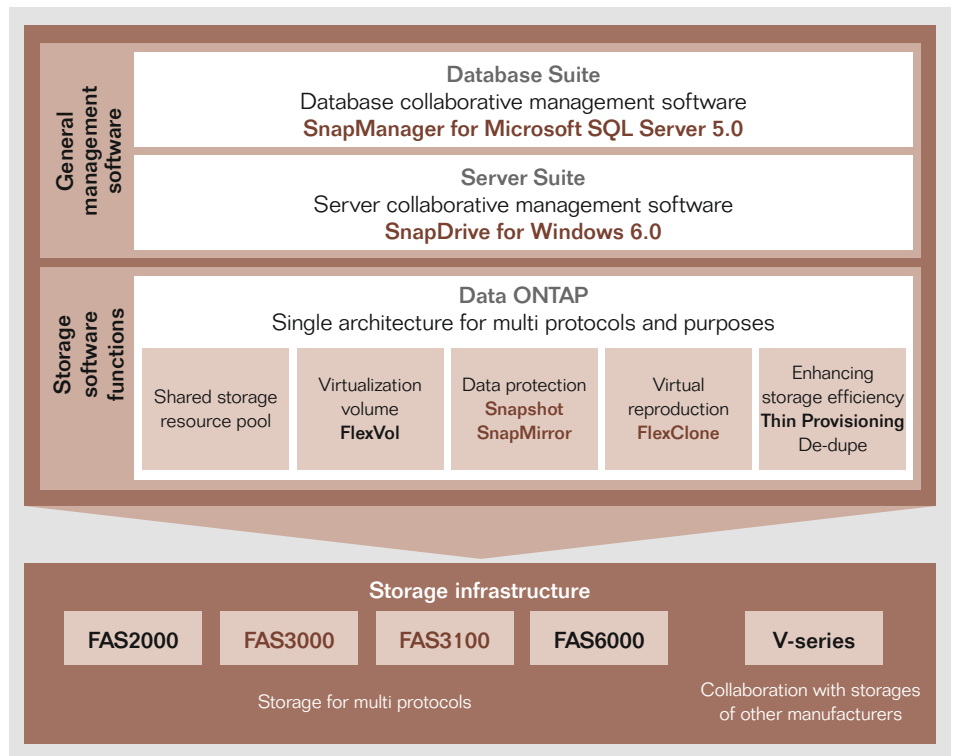

Figure 6: Overview of general data management solution supplied by NetApp

that previously could be carried out only on the storage side – and allows the server or database administrator to use storage functions such as backing up and restoring without any professional knowledge. Therefore, in an actual operation situation, the server or database administrator is expected to backup or restore data.

Performance in an FCoE environment verified

SnapDrive for Windows supports FC and iSCSI as a standard. In this configuration, the FCoE connection was also tested. The storage (NetApp FAS series) was tested while operating the

application in an environment where it was connected with the data center class switch NEXUS 5020, using FC via FC switch MDS 9222i. The server with an Intel® Xeon® 5500 series processor was connected with Nexus 5020, using FCoE. The result was noteworthy, because although many connection test results using only FCoE were reported by vendors, few tests at the application level had been conducted. It is also expected to reduce TCO (total cost of ownership) during the transition period when changes are gradually made for the server to use the FCoE connection, with the storage retaining the FC connection.

Advanced architecture of NetApp

Snapshot

Snapshot, one of the basic Data ONTAP functions, acquires online backup images during system operation. The most advantageous features include its excellent space efficiency, no deteriorated writing performance, and flexible operation per volume unit, which make it possible for the user to obtain backups very often, and to significantly reduce recovery time.

Snapshot obtains only metadata blocks at a certain point in time, rather than making a physical copy of the entire volume for backup. Therefore, it has none of the deteriorated performance that is seen in the Snapshot that adopts the so-called copy-out method. Implementation can be conducted per volume and the obtained Snapshot image is saved separately in the hidden directory in each volume. Acquisition and recovery of Snapshot does not affect the other volumes, and operation rules for each volume can be determined flexibly.

SnapMirror

SnapMirror is a backup function applying Snapshot. It transfers only changed data blocks to the destination after the first 0 level transfer (whole data transfer of the targeted volume). One special feature of SnapMirror is that it transfers data as if a full copy image for each transfer is being saved, even though only the differential data is transferred after the first transfer.

In this test, backup images for the previous seven sessions were saved, but the data used was not seven times the original – the images were saved using much less data. In addition, SnapMirror can make rapid transfers by LAN or WAN, since it uses less network traffic by transferring only the differential data. For the data transfer channel, users can use IP networks and also FC networks.

FlexClone

FlexClone instantly creates a clone of the disc volume within the storage. It applies Snapshot technology to make a backup only for differential data blocks. It is able to instantly create a clone by copying only logical data, without making a physical copy (thus, similar to Snapshot's approach). In fact, it can create a clone using only 10% of the original amount of data when creating a clone, which means that the same amount as that of the original is not required for creating clones. Data copied by FlexClone is readily available for reading and writing, while copied data created by Snapshot was for read only. This allows the user to conduct different kinds of tests using clones.

ESTABLISHING THE NETWORK ENVIRONMENT

OPTIMAL I/O INTEGRATION FOR DR FOR THE SAP SYSTEM, AND OPTIMIZED WAN

Cost reduction by FCoE protocol

One of the special features of the demonstration tests was the participation of Cisco Systems, which made it possible to establish a network platform using the latest network technology, FCoE (Fibre Channel over Ethernet). FCoE is a protocol to connect interfaces with FC and Ethernet connections, for which standardization is promoted. It does not require separate infrastructures for LAN and SAN, and integrates I/O. The 10Gbps connection makes a broadband environment available.

The reason for using FCoE in the demonstration test was to handle the I/O traffic, which increases with virtualization. When a server is virtualized, multiple virtual machines run on one physical server, so the traffic amount for each physical server is increased. As the number of virtual servers increases, LAN, SAN and server traffic increases, leading to more complicated wiring and overloaded operations. The demonstration tests therefore examined ways to reduce cables, switches and interfaces, by establishing a network environment using the FCoE protocol. This would lead to less network management and lower costs, including less power consumption (and therefore greener IT operations).

Connections to the server and storage

Each physical server is connected with a Cisco Nexus 5020 data center class switch, using FCoE. The Cisco Nexus 5020 is connected with NetApp's storage using FC via a Cisco MDS 9222i FC switch. The connection between the switch and the storage was tested for multiplexing by virtualizing the SAN, using the VSAN (Virtual SAN) function of the Cisco MDS 9222i while maintaining its independency. A Cisco Catalyst 3750E was used for the Ethernet switch, and connected with a Cisco Nexus 5020 using 10GB Ethernet. Between the operation and DR sites, the cost-effective option of a VPN was used.

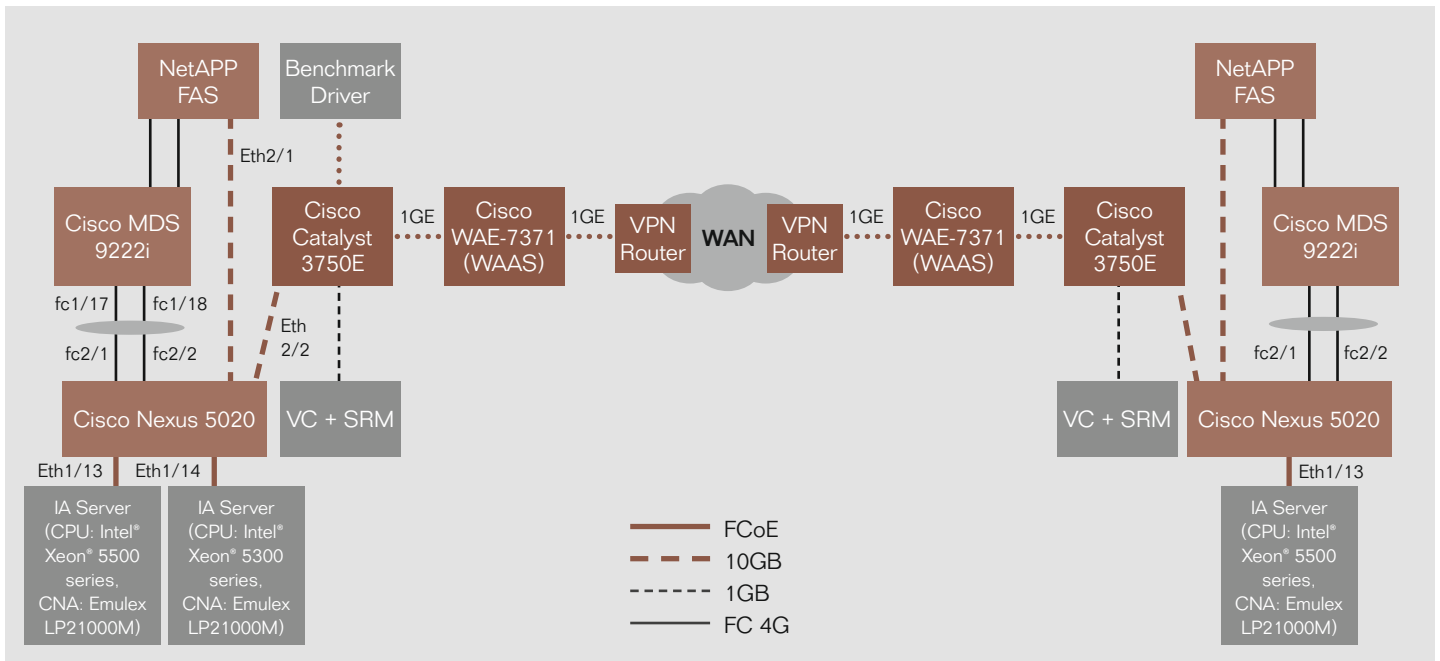

Figure 7: Network environment

WAAS, the WAN acceleration solution

In the demonstration tests, Cisco Systems' WAN acceleration solution called WAAS was used to enhance the efficiency of transferring data between the sites. WAAS technology is used to achieve the same performance as a LAN, but on a WAN. The amount of data to be sent to the WAN is reduced by combining DRE (Data Redundancy Elimination), which optimizes bandwidth on WANs based on data redundancy and data compression. In addition, WAN throughput is improved by TFO (Transport Flow Optimization), which optimizes TCP traffic. Delays are re-

duced to achieve effective use of bandwidth, using technologies such as look-ahead, alternative protocol and caching.

Using WAAS to achieve effective use of bandwidth

According to the Network Traffic Summary Report for WAAS, performance measured in the test environment resulted in 4.92 times greater effective capacity in Osaka, and 5.64 times greater in Tokyo. The bandwidth usage rate was over 80% at both sites, proving that bandwidth was used more effectively than before adopting WAAS (See Figure 8).

Storage replication is also accelerated. Before adopting WAAS, the throughputs to send SAP ERP data from the operation site to the DR site were 60.04 (KB/sec) and 61.82 (KB/sec) for the data area, and 101.84 (KB/sec) for the log data. After adopting WAAS, they were 228.20 (KB/sec), 219.26 (KB/sec) and 248.45 (KB/sec) – 2 to 3.5 times faster (See Figure 9).

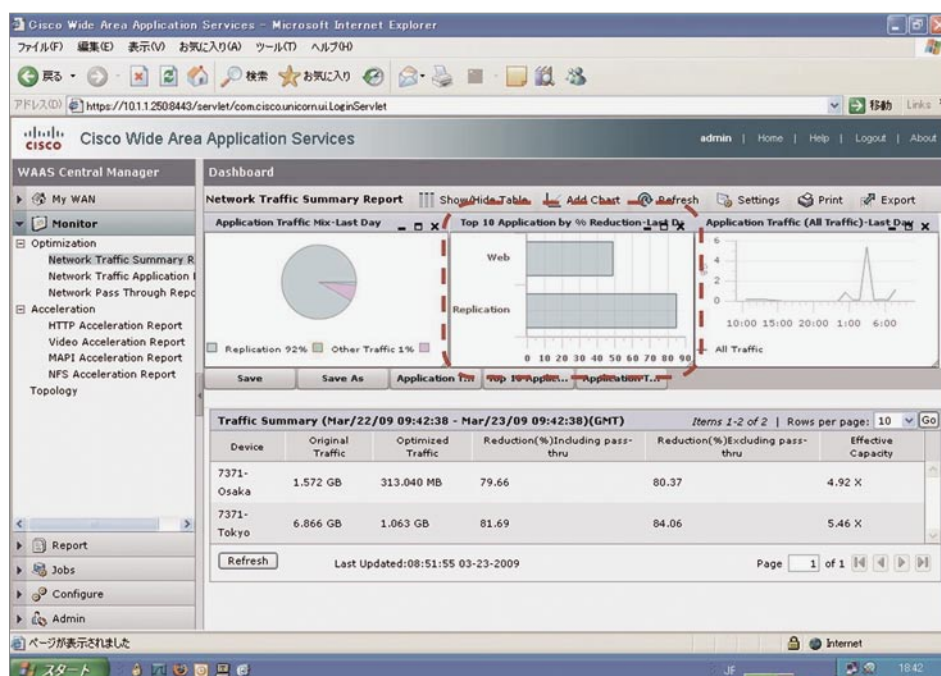

Figure 8: Results of Network Traffic Summary Report
According to the Network Traffic Summary Report for WAAS, effective capacity was 4.92 times greater in Osaka and 5.46 times greater in Tokyo. The bandwidth is used more efficiently, with a usage rate of more than 80% at both sites.

Key points for establishing a network environment

The demonstration tests show that environments where switches and adapters were previously needed for both LAN and SAN can be integrated by establishing a connection from the server and the storage to FCoE, with NIC and HBA being consolidated with CNA (Converged Network Adapter). Management efficiency can also be improved by using VLAN and VSAN in virtualization. Furthermore, the 10 Gbps environment permits the development of the virtual environment and improves the performance of VMware VMotion and SRM.

In addition, it was proven that even inexpensive WAN connections can achieve satisfactory performance through the use of WAAS. In fact, a very cost-effective environment can now be established for DR strategies, which were previously ignored because of formerly high running costs and the cost-boosting distance between the sites.

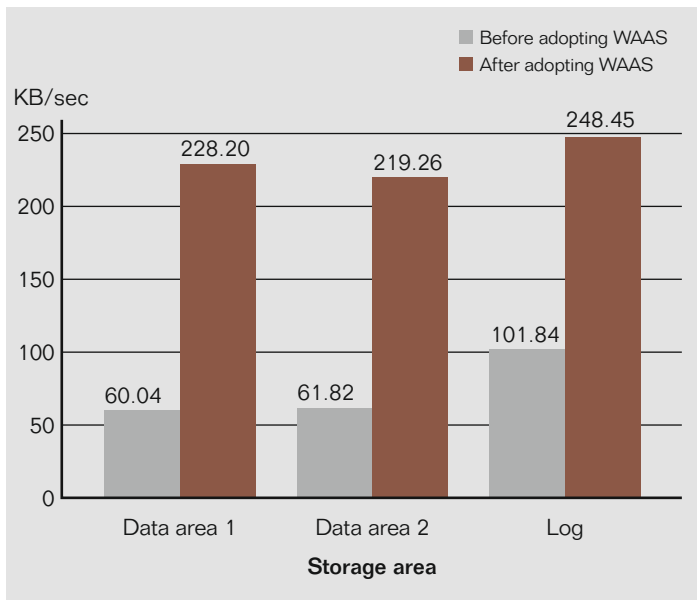

Figure 9: Results of tests for improved throughput by WAAS
By adopting WAAS, the time required for replicating the storage was 2 to 3.5 times shorter for both data and log areas

DISASTER RECOVERY IN A VIRTUAL ENVIRONMENT

VMware vCenter Site Recovery Manager (SRM) AUTOMATES DISASTER RECOVERY

Failover in a virtual environment

If the system must be shut down due to any disaster at the operation site, the system should be failovered at the recovery site to restart business operations immediately. However, this is very difficult to do in conventional DR environments, because the server must be connected with an external storage device or the recovery process must be carried out manually by an administrator. There are many cases where the recovery process remains untested, since much time and work are required to prepare an updated DR plan to meet the daily demands of a changing system environment.

To resolve these issues, VMware vCenter Site Recovery Manager (hereinafter SRM), which automates disaster recovery in a virtual environment, was used in the demonstration tests to verify both the seamless connection with the storage and the automation of the recovery process. SRM is a new solution released in June 2008. The demonstration tests were an excellent opportunity to test SRM's performance in a remote environment.

In the demonstration tests, a server for SRM was installed at both the operation site and the recovery site, so that if the operation site failed a virtual machine with the same configuration could take over at the recovery site. The data accessed by the virtual machine at the recovery site uses the backup volume replicated by NetApp's SnapMirror. The test was automatically started by pressing the recovery button of the SRM on the vCenter Server, and

proper restoration was verified. SRM works with NetApp's storage – when the SRM's DR plan is implemented, SnapMirror is stopped automatically and the SRM starts the virtual machine automatically by calling up the data from the recovery volume, according to the recovery plan prepared in advance.

The results show that a fast and effective failover can be successfully carried out under various environments with a different number of servers at the operation site and recovery site. RTO was about 1 hour, much less than the targeted time of 2 hours. This test was implemented in an environment with a minimum number of virtual machines (two physical servers at the operation site and one at the recovery site). The greater the number of servers installed, the greater the benefits from automation. Therefore, SRM may be one of the most optimal solutions in environments where rapid disaster recovery is required.

Mock disaster response, to test recovery plans as often as desired

SRM includes a function to conduct drills to test the entire recovery process. Using the Snapshot function of the storage, users can conduct drills as frequently as they want by connecting the virtual machine to an isolated test network without interrupting the actual environment. Conventional DR systems involve a complicated process to carry out recovery tests, and sometimes impact negatively on actual business operations. With such a conventional system, many companies do not have enough time to carry out recovery tests, and avoid them because of the associated business risk. In some cases, additions or changes are made to the system after recovery test complications, making managers reluctant to conduct another recovery test. SRM lets users conduct automatic tests using the recovery plan at any time without interrupting on-site operations,

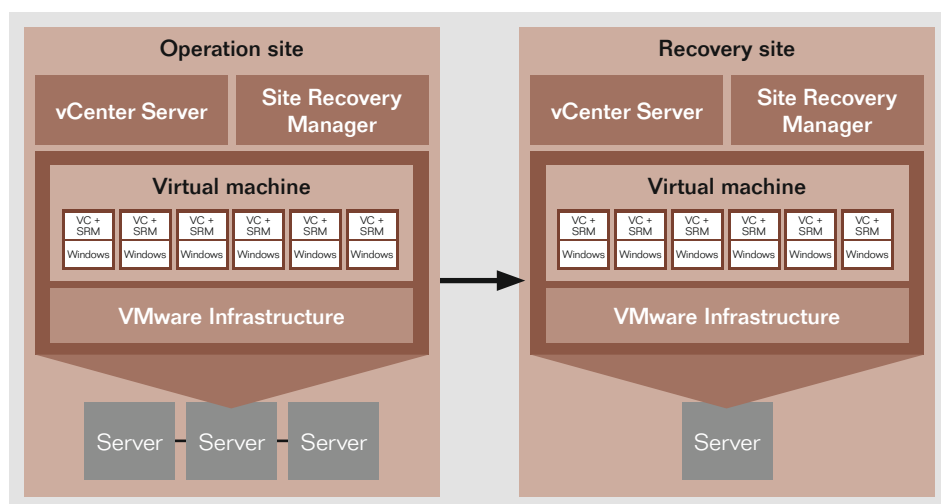

Figure 10: VMware vCenter Site Recovery Manager concept

while maintaining a highly reliable recovery environment.

In the demonstration tests, a clone volume of the recovery data saved in the DR storage system was created instantly, using NetApp's FlexClone. The recovery plan and the test scenario were implemented in separate test environments. After completion of the test, the test environment was completely restored to original pre-test conditions. The test results were saved in the vCenter Server, allowing for easy verification.

Major functions of the Site Recovery Manager

Automated failover

- Running the recovery plan with a single touch of a button using the vCenter Server

- Automatically replicating data store for recovery
- Implementing or stopping a user-defined script during the recovery process
- Reconfiguring the IP address of the virtual machine to match the network configuration of the failover site
- Managing and monitoring the implementation of the recovery plan using the vCenter Server

Achieving test with no downtime

- Conducting recovery tests using the SnapShot function of the storage device, without affecting data to be replicated
- Connecting the virtual machine with a separate network for testing purposes
- Automatically conducting tests of the recovery plan

- Customizing recovery plan implementation, in accordance with the test scenario
- Cleaning up the test environment automatically after test completion

Disaster recovery management

- Detecting and displaying the virtual machine to be protected using the replication function of the storage device
- Creating and managing the recovery plan directly from the vCenter Server
- Saving, displaying and exporting test results and failover implementation results from the vCenter Server



Figure 11: Button to run the recovery plan

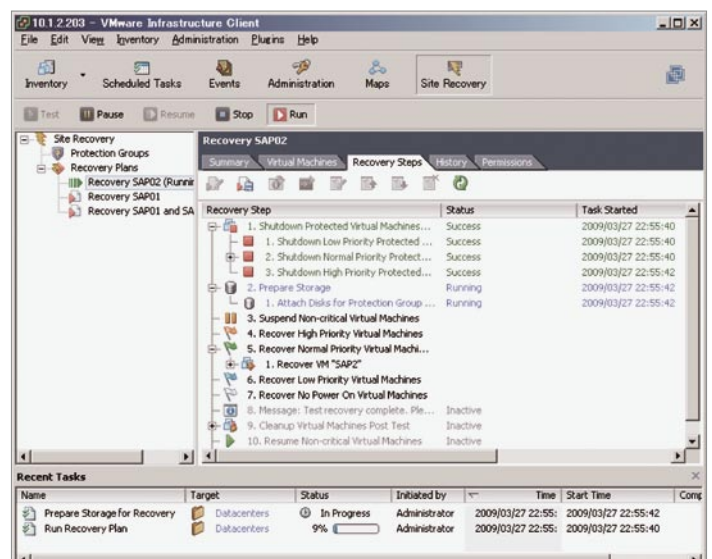

Figure 12: Screen to run the recovery plan

DISASTER RECOVERY POTENTIAL USING VIRTUALIZATION TECHNOLOGY

TARGETING EFFECTIVE USE OF THE DR SITE

DR measures using virtualization technology that benefits from an advanced technological environment

Many results were obtained from this project, proving that virtualization technology is effective for DR measures applied to an SAP ERP system. DR measures using virtualization provide great benefits during operation, including quick recovery in case of a disaster, and the ability to conduct mock disaster drills while operations at the actual site continue running. These various advantages contribute to the reduction of TCO.

These positive results are certainly options for SAP users who need to ensure both business continuity and disaster recovery, and who have depended on the reliability of a less efficient physical environment to implement DR measures, or who have postponed the adoption of the DR solutions because of the cost. Virtualization can also be applied to ERP in an SaaS environment promoted by SAP, and in establishing a private cloud environment achieved by advances in virtualization technology. Virtualization technology is also developing at the operational level, taking actual business needs into consideration.

Effective use of the DR site: Improving the value of IT assets

Future challenges for our research include finding ways to effectively use the DR site as part of daily business operations. After all, it is especially difficult for small and medium-sized companies to obtain a return on investment when installing IT assets that would only be used for disaster recovery measures.

In this respect, SAP Co-Innovation Lab Tokyo is studying a detailed scenario in which a DR site could also be used effectively during daily business operations. For example, it may be possible to establish a development or test environment using data replicated to the DR site, without stopping synchroniza-

tion from the operation site, or to use as a test instance employing the actual business data by creating a replication by FlexClone only of the data volume of SQL Server out of the synchronized volume and attaching it to another SAP instance. SAP Co-Innovation Lab Tokyo will continue to conduct demonstration tests to examine issues springing from the needs of a variety of companies.

Our recent demonstration tests covered the process until failover at the DR site, and did not test failback to the operation site. In the future, the Lab will test environments that are more realistic from a business perspective, taking into consideration failback procedures that also include overseas sites.

Benefits Proven by Phase II of the Disaster Recovery Project of SAP Co-Innovation Lab Tokyo

1. A low-cost disaster recovery platform can be established by virtualization
2. Smooth failover using VMware's DR solution and NetApp's storage technology was achieved
3. An Intel® Xeon® 5500 series processor improves performance in a virtual environment
4. I/O is integrated through FCoE
5. Speeding up replication for the DR site, using Cisco's WAN optimization solution.
6. A DR site can be established even with an inexpensive WAN, using the WAAS WAN optimization solution

© 2009 by SAP AG.

All rights reserved. SAP, R/3, SAP NetWeaver, Duet, PartnerEdge, ByDesign, SAP Business ByDesign, and other SAP products and services mentioned herein as well as their respective logos are trademarks or registered trademarks of SAP AG in Germany and other countries.

Business Objects and the Business Objects logo, BusinessObjects, Crystal Reports, Crystal Decisions, Web Intelligence, Xcelsius, and other Business Objects products and services mentioned herein as well as their respective logos are trademarks or registered trademarks of Business Objects S.A. in the United States and in other countries. Business Objects is an SAP company.

All other product and service names mentioned are the trademarks of their respective companies. Data contained in this document serves informational purposes only. National product specifications may vary.

These materials are subject to change without notice. These materials are provided by SAP AG and its affiliated companies ("SAP Group") for informational purposes only, without representation or warranty of any kind, and SAP Group shall not be liable for errors or omissions with respect to the materials. The only warranties for SAP Group products and services are those that are set forth in the express warranty statements accompanying such products and services, if any. Nothing herein should be construed as constituting an additional warranty.

www.sap.com/contactsap

THE BEST-RUN BUSINESSES RUN SAP™

